

KOGANEI

ACCESSORIES GENERAL CATALOG

AIR TREATMENT, AUXILIARY, VACUUM, AND FLUORORESIN PRODUCTS

COOL SEPARATOR

COOL SEPARATOR CONTENTS



Features, Dehumidifying Principles	161
Order Codes, Specifications, Dimensions	162
Handling Instructions and Precautions	163



Caution

Before use, be sure to read the "Safety Precautions" on p. 49.

Simple Solution for Supply of Dry Air

Differential Pressure Dehumidifier

COOL SEPARATOR

- Set anywhere along the piping system to obtain dry air without effort.

Differential pressure type achieves lightweight, compact unit. Furthermore, power supply is unnecessary, for delivery of dry air without effort.

- Koganei's own configuration responds to changes in flow rate volumes.

Because it demonstrates reliable dehumidification performance even during fluctuations in flow rate or pressure, it is optimum for air control at the end of air lines.

- No maintenance

It does not use filters, and therefore does not have clogging problems. Moreover, collected liquid or contaminants are automatically removed via an auto drain trap.

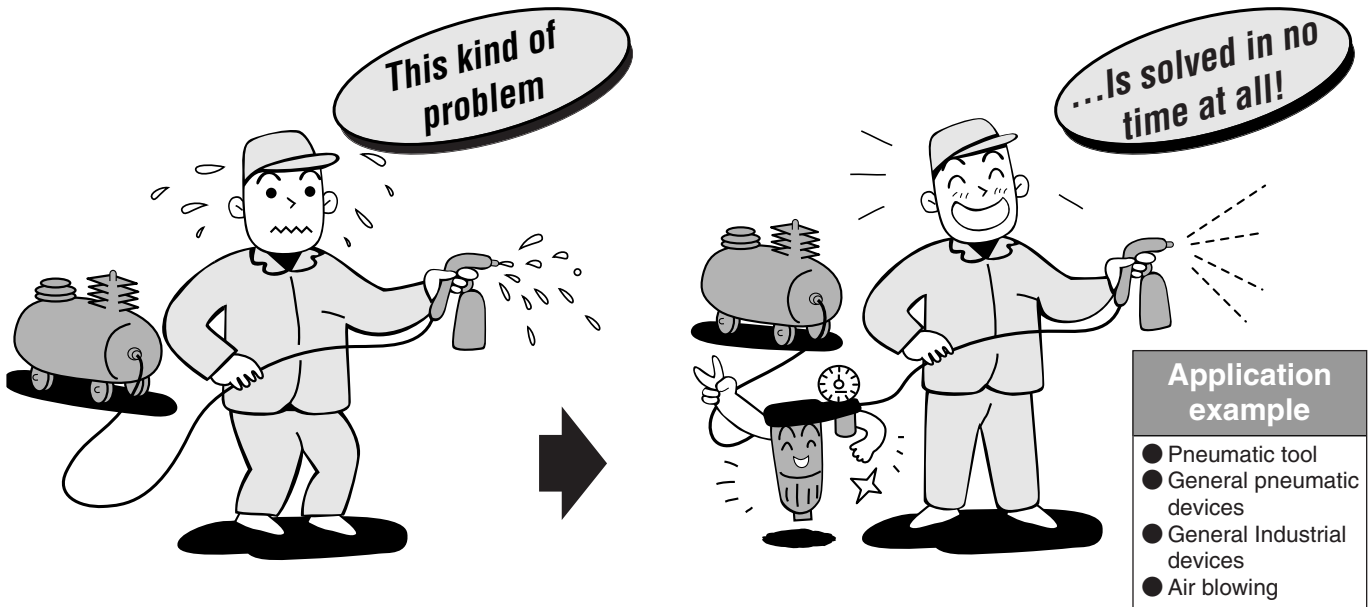

Dehumidifying Principles

- 1 Separates out oversaturated moisture.**
Uses Koganei's own rotating louver to generate a highly efficient centrifugal force that sends heavy moisture flying outward while collecting foggy vapor in the center.
- 2 Forms foggy vapor into droplets.**
The foggy vapor collected in the center comes into contact with the walls of the device, chilling it. It condenses into droplets that are sent flying outward by the centrifugal force.
- 3 Uses collision separation on microscopic vapor.**
Microscopic aerosol vapor collides with a baffle to form water droplets.
- 4 Gravitationally separates out water droplets.**
Air entering the bowl is reliably separated into moisture and air, with water droplets collected toward the bottom.
- 5 Koganei's own mechanism chills walls of the device.**
Uses Koganei's own mechanism for adiabatic expansion that chills the walls of the device.
- 6 Exchanges heat with intake air.**
Air chilled by adiabatic expansion exchanges heat with intake air, drying the air.
- 7 Water droplets collected in the bowl are ejected out of the device by a float.**

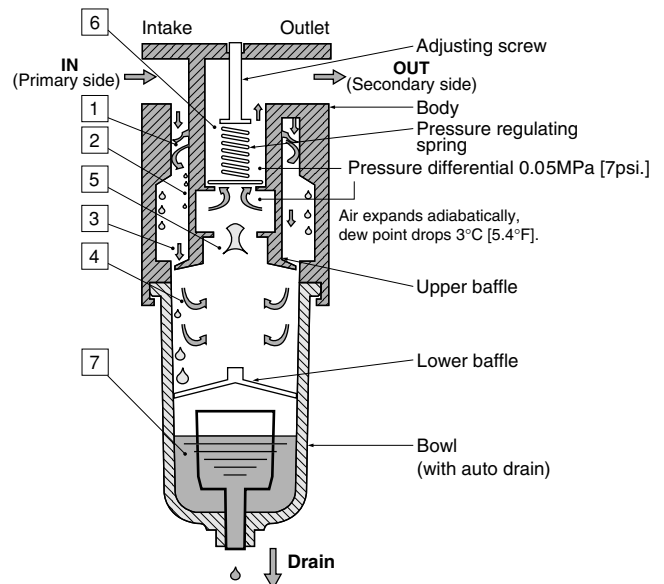

Order Codes

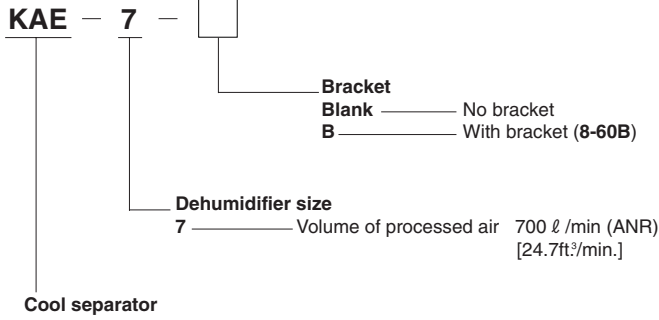

Option (Required when using the cool separator as a single unit.)

Bracket — **8-60B**

Note: Pipe supporting type brackets (8-60B) are sold in a set of two brackets.

Remark Because there is no filter mechanism on the cool separator, use it with air filter (5μm) mounted.
 Air filter: **F600-03-A**
 Connection module: **8-60D**

Specifications

Caution Do not use in locations where the ambient temperature can become lower than the cool separator intake air temperature. The air can re-condense if the temperature sinks too low.

Item	Model	KAE-7
Performance	Volume of processed air ^{Note} ℓ/min [ft ³ /min] (ANR)	700 [24.7]
	Dew point drop ^{Note} °C [°F]	3 [5.4] (When pressurized)
Operating range	Media	Air
	Operating temperature range °C [°F]	2~60 [35.6~140]
	Operating pressure range MPa [psi.]	0.1~0.99 [14.5~144]
Mass	kg [lb.]	1.1 [2.2]
Air outlet/intake port size		Rc1/2
Auto drain trap		Float type
Applicable compressor	kW	5

Note: (Measuring conditions)

Intake air pressure : 0.5MPa [73psi.]
 Intake air temperature: 30°C [86°F]
 Ambient temperature: 30°C [86°F]

Recommended Maximum Flow Rate

● The recommended maximum flow rate for the cool separator is shown in the graph below. Always use at flow rate below the line shown in the graph.

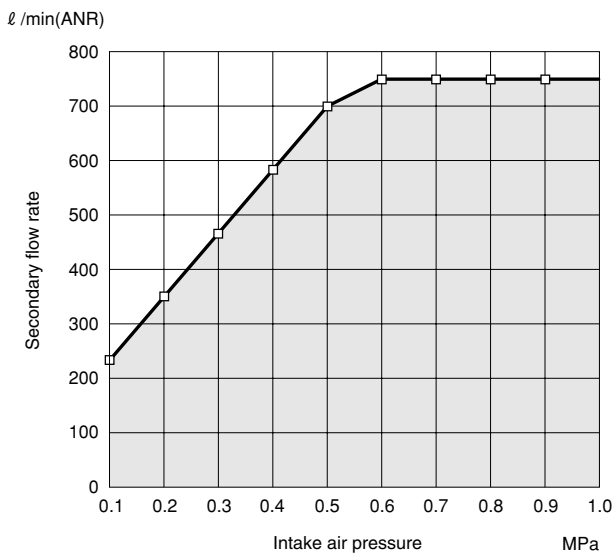

1Mpa = 145psi. 1 ℓ/min = 0.0353ft³/min.

Dimensions (mm)

●KAE-7-B

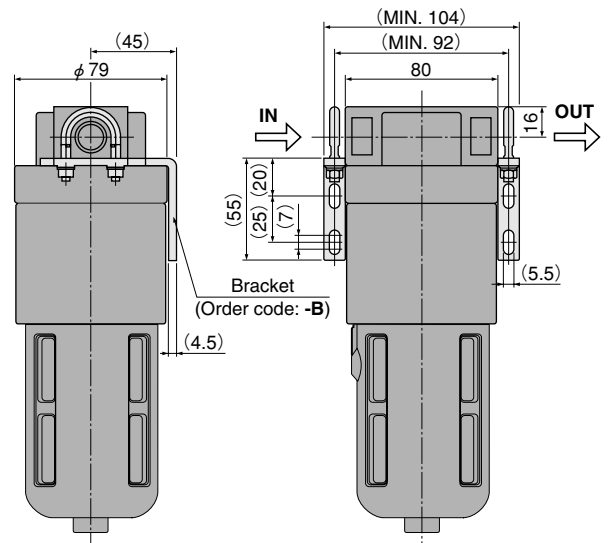

COOL SEPARATOR





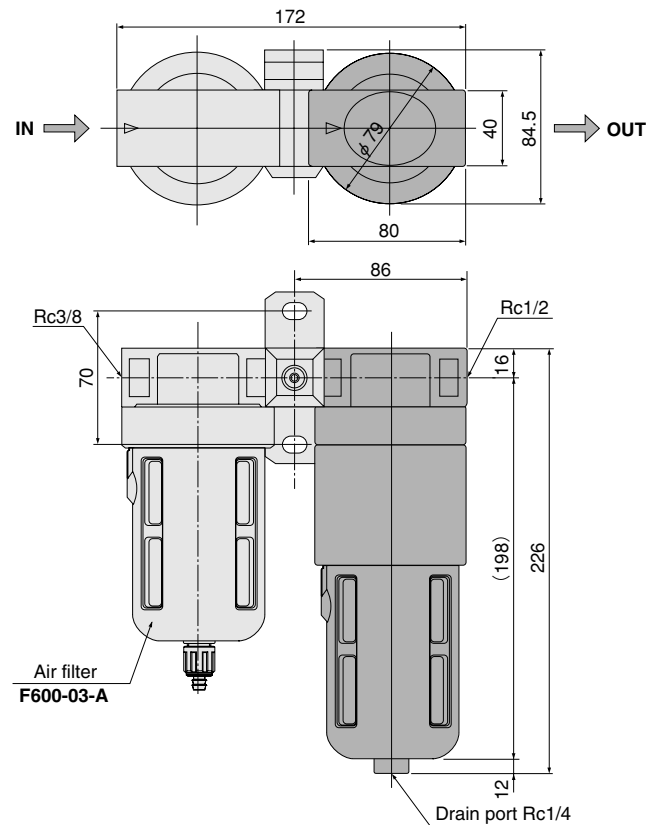

●KAE-7+F600-03-A+8-60D (When air filter mounted)

Remark: The air filter (**F600-03-A**) and D module (**8-60D**) are sold separately.



Cool Separator System (Reference)

Caution: Always mount an air filter (5 μ m) in upstream of the cool separator for use.

Air filter (5 μ m)	Connection module	Cool separator	Connection module	Mist filter (0.3 μ m)	Connection module	Regulator
						
With auto drain ^{Note}				With auto drain ^{Note}		
F600-03-A ^{Note}	8-60D	KAE-7	8-60D	MF600-03-A ^{Note}	8-40D	R300-03

 denotes the absolute minimum system.

Note: Some models without auto drain are available. To order such models, remove -A from the order code.

In the auto drain, air is exhausted from the drain port until the supply pressure reaches 0.15MPa [22psi.], and this is normal operations. In this situation, even rotating the drain knob will not prevent the air from bleeding out. If too much time is being required for supply pressure to rise to 0.15MPa [22psi.], consult us.

Handling Instructions and Precautions



Mounting and piping

1. Avoid placement near air compressors. To ensure that the intake air temperature is the same as the ambient temperature, mount as close to the pneumatic equipment as possible.

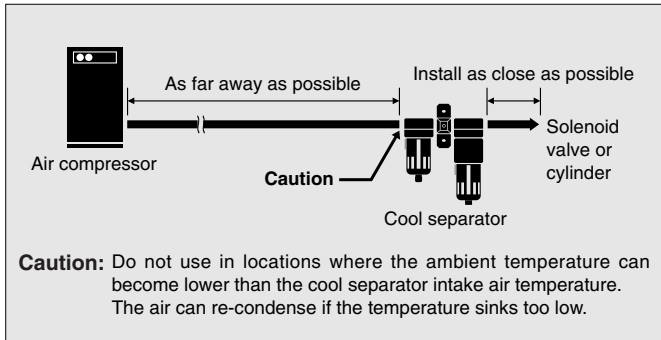

2. Use with intake air and ambient temperature in a range of 2°C to 60°C [35.6~140°F].
3. Mount the device vertically with the bowl on the bottom side. In addition, leave the space to facilitate maintenance (minimum of 100mm [3.94in.] from the floor).



General precautions

1. Always thoroughly blow off (use compressed air) the tubing before piping. Entering chips, sealing tape, rust, etc., generated during piping work could result in air leaks or other defective operation.
2. The product cannot be used when the media or the ambient atmosphere contains any of the substances listed below. Organic solvents, phosphate ester type hydraulic oil, sulphur dioxide, chlorine gas, chlorofluorocarbon or acids, etc.
3. If using in locations subject to dripping water, dripping oil, etc., or to large amounts of dust, use something to cover and protect the unit.